

N-Channel 30-V (D-S) Rated MOSFET

Product Summary

V_{DS} (V)	$r_{DS(on)}$ (Ω)	I_D (A)
30	0.045 @ $V_{GS} = 10$ V	± 4.4
	0.070 @ $V_{GS} = 4.5$ V	± 3.5

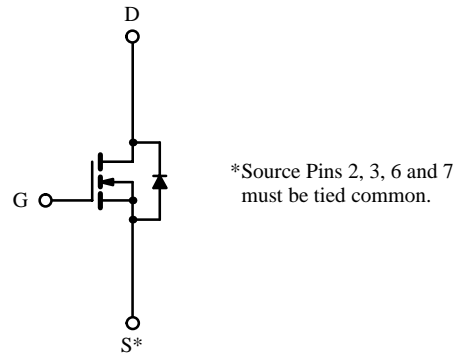
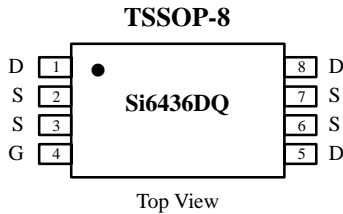

N-Channel MOSFET

Absolute Maximum Ratings ($T_A = 25^\circ\text{C}$ Unless Otherwise Noted)

Parameter	Symbol	Limit	Unit
Drain-Source Voltage	V_{DS}	30	V
Gate-Source Voltage	V_{GS}	± 20	
Continuous Drain Current ($T_J = 150^\circ\text{C}$) ^a	I_D	$T_A = 25^\circ\text{C}$	± 4.4
		$T_A = 70^\circ\text{C}$	± 3.5
Pulsed Drain Current	I_{DM}	± 30	A
Continuous Source Current (Diode Conduction) ^a	I_S	1.7	
Maximum Power Dissipation ^a	P_D	$T_A = 25^\circ\text{C}$	1.5
		$T_A = 70^\circ\text{C}$	1.0
Operating Junction and Storage Temperature Range	T_J, T_{stg}	-55 to 150	$^\circ\text{C}$

Thermal Resistance Ratings

Parameter	Symbol	Limit	Unit
Maximum Junction-to-Ambient ^a	R_{thJA}	83	$^\circ\text{C}/\text{W}$

Notes

a. Surface Mounted on FR4 Board, $t \leq 10$ sec.

Updates to this data sheet may be obtained via facsimile by calling Siliconix FaxBack, 1-408-970-5600. Please request FaxBack document #70169. A SPICE Model data sheet is available for this product (FaxBack document #70535).

Si6436DQ

Specifications ($T_J = 25^\circ\text{C}$ Unless Otherwise Noted)

Parameter	Symbol	Test Condition	Min	Typ	Max	Unit
Static						
Gate Threshold Voltage	$V_{GS(th)}$	$V_{DS} = V_{GS}, I_D = 250 \mu\text{A}$	1			V
Gate-Body Leakage	I_{GSS}	$V_{DS} = 0 \text{ V}, V_{GS} = \pm 20 \text{ V}$			± 100	nA
Zero Gate Voltage Drain Current	I_{DSS}	$V_{DS} = 30 \text{ V}, V_{GS} = 0 \text{ V}$			1	μA
		$V_{DS} = 30 \text{ V}, V_{GS} = 0 \text{ V}, T_J = 55^\circ\text{C}$			20	
On-State Drain Current ^a	$I_{D(on)}$	$V_{DS} = 5 \text{ V}, V_{GS} = 10 \text{ V}$	20			A
Drain-Source On-State Resistance ^a	$r_{DS(on)}$	$V_{GS} = 10 \text{ V}, I_D = 4.4 \text{ A}$		0.034	0.045	Ω
		$V_{GS} = 4.5 \text{ V}, I_D = 3.0 \text{ A}$		0.052	0.070	
Forward Transconductance ^a	g_{fs}	$V_{DS} = 15 \text{ V}, I_D = 4.4 \text{ A}$		8		S
Diode Forward Voltage ^a	V_{SD}	$I_S = 1.7 \text{ A}, V_{GS} = 0 \text{ V}$		0.75	1.2	V
Dynamic^b						
Total Gate Charge	Q_g	$V_{DS} = 15 \text{ V}, V_{GS} = 10 \text{ V}, I_D = 4.4 \text{ A}$		13	30	nC
Gate-Source Charge	Q_{gs}			1.7		
Gate-Drain Charge	Q_{gd}			3.7		
Turn-On Delay Time	$t_{d(on)}$	$V_{DD} = 15 \text{ V}, R_L = 15 \Omega$ $I_D \cong 1 \text{ A}, V_{GEN} = 10 \text{ V}, R_G = 6 \Omega$		12	30	ns
Rise Time	t_r			10	25	
Turn-Off Delay Time	$t_{d(off)}$			25	30	
Fall Time	t_f			10	50	
Source-Drain Reverse Recovery Time	t_{rr}	$I_F = 1.7 \text{ A}, di/dt = 100 \text{ A}/\mu\text{s}$		120	160	

Notes

- a. Pulse test; pulse width $\leq 300 \mu\text{s}$, duty cycle $\leq 2\%$.
b. Guaranteed by design, not subject to production testing.

Typical Characteristics (25°C Unless Otherwise Noted)

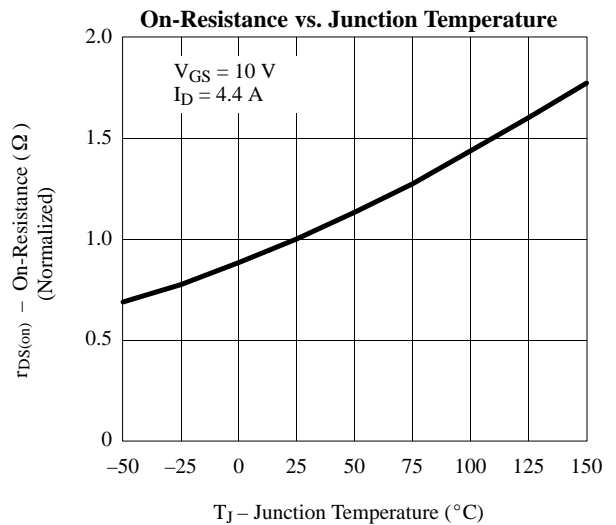
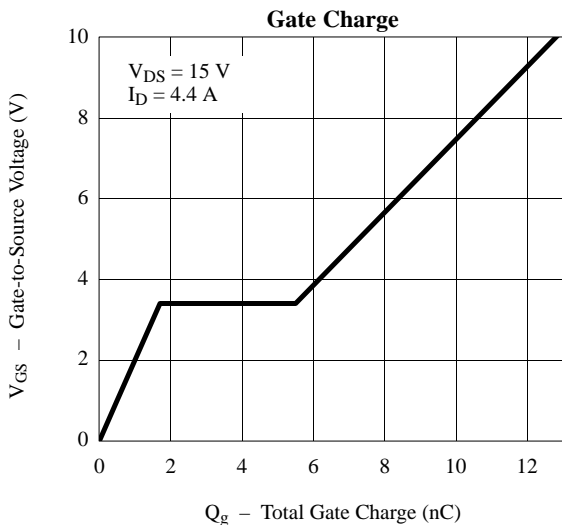
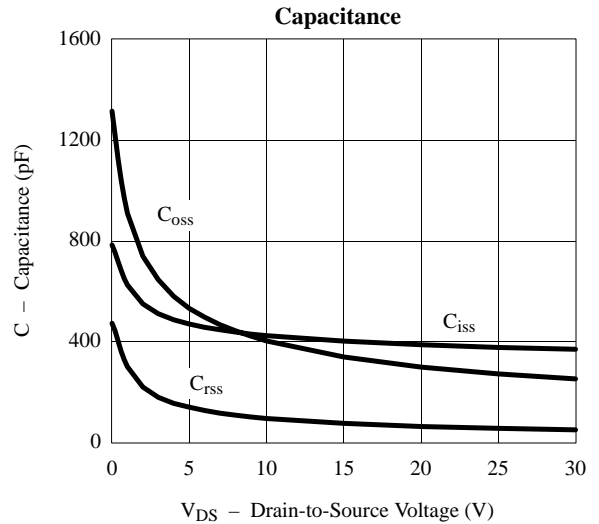
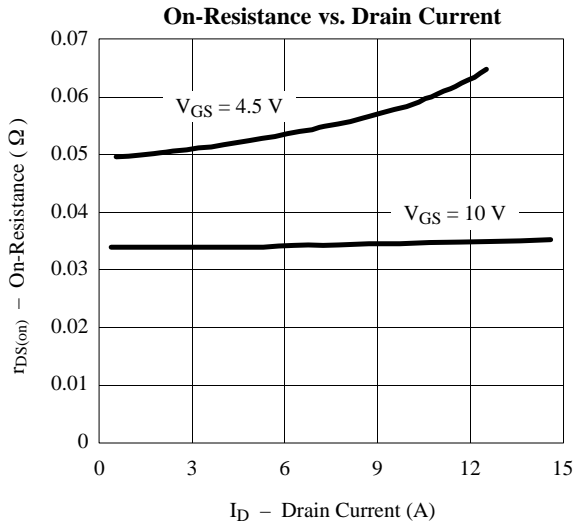
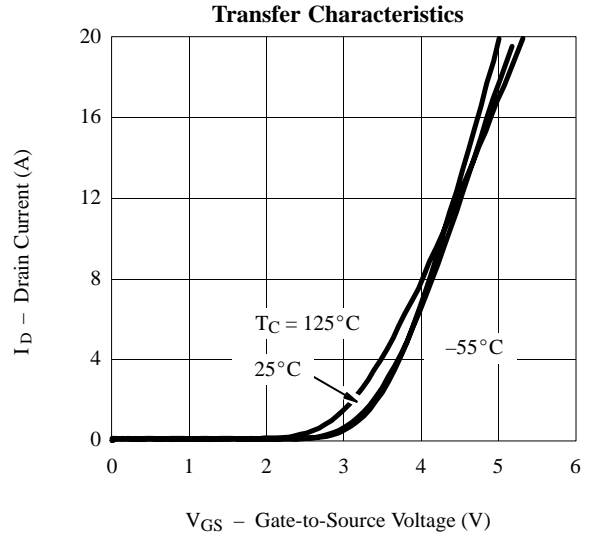
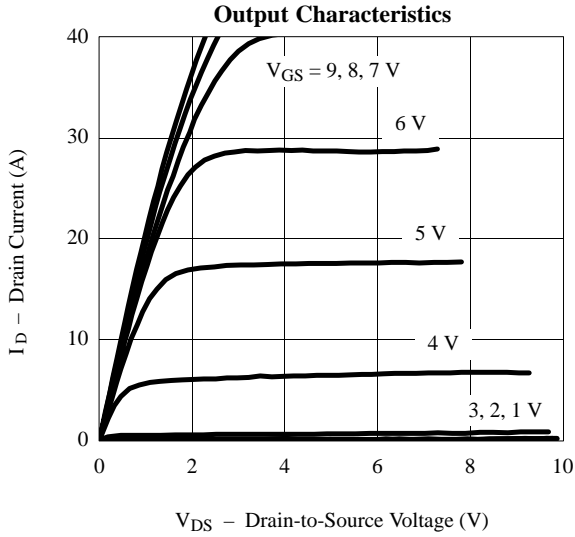

Si6436DQ

Typical Characteristics (25°C Unless Otherwise Noted)

